



# İLKE

İTHALAT ve İHRACAT  
DİŐ TİC. LTD. ŐTİ.



Türkiye

Gücünü ve  
Potansiyelini Keşfet

2023





# Yaratıcı, yenilikçi, pratik, dayanıklı...

ilken'in hem tüketicinin, hem de üreticinin ihtiyaçlarını gözetererek hazırladığı **Menteşe Sistemleri**'nde, her mobilyaya uyum sağlayabilen pek çok farklı seçenek var. Hayat artık herkes için çok daha kolay, çok daha keyifli.

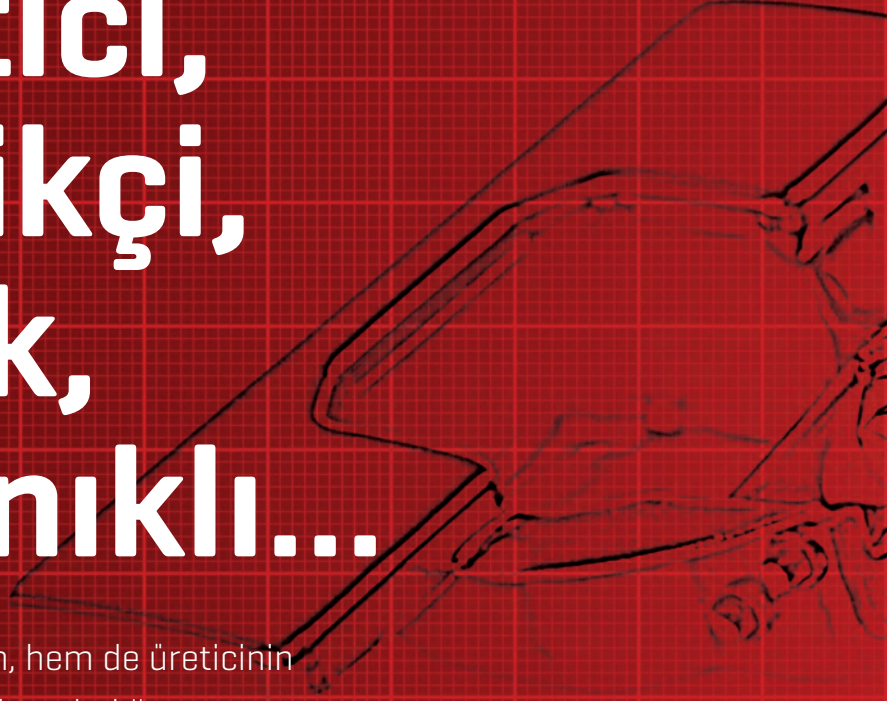



Başarılar Hayal Etmekle Başlar ...



**KALİTE POLİTİKAMIZ**

Teknolojik yenilikleri kullanarak ürün çeşitliliğini verimliliğini ve hizmet kalitesini sürekli iyileştirmek ve sektörde daima yenilikçi ve öncü firma olmak hedefi mizdir. Müşteri memnuniyetini maksimum seviyeye ulaştırmak için uluslar arası kalite, güvenilir insan ve yaşam alanı içinde geliştirilmiş dizayn edilmiştir.

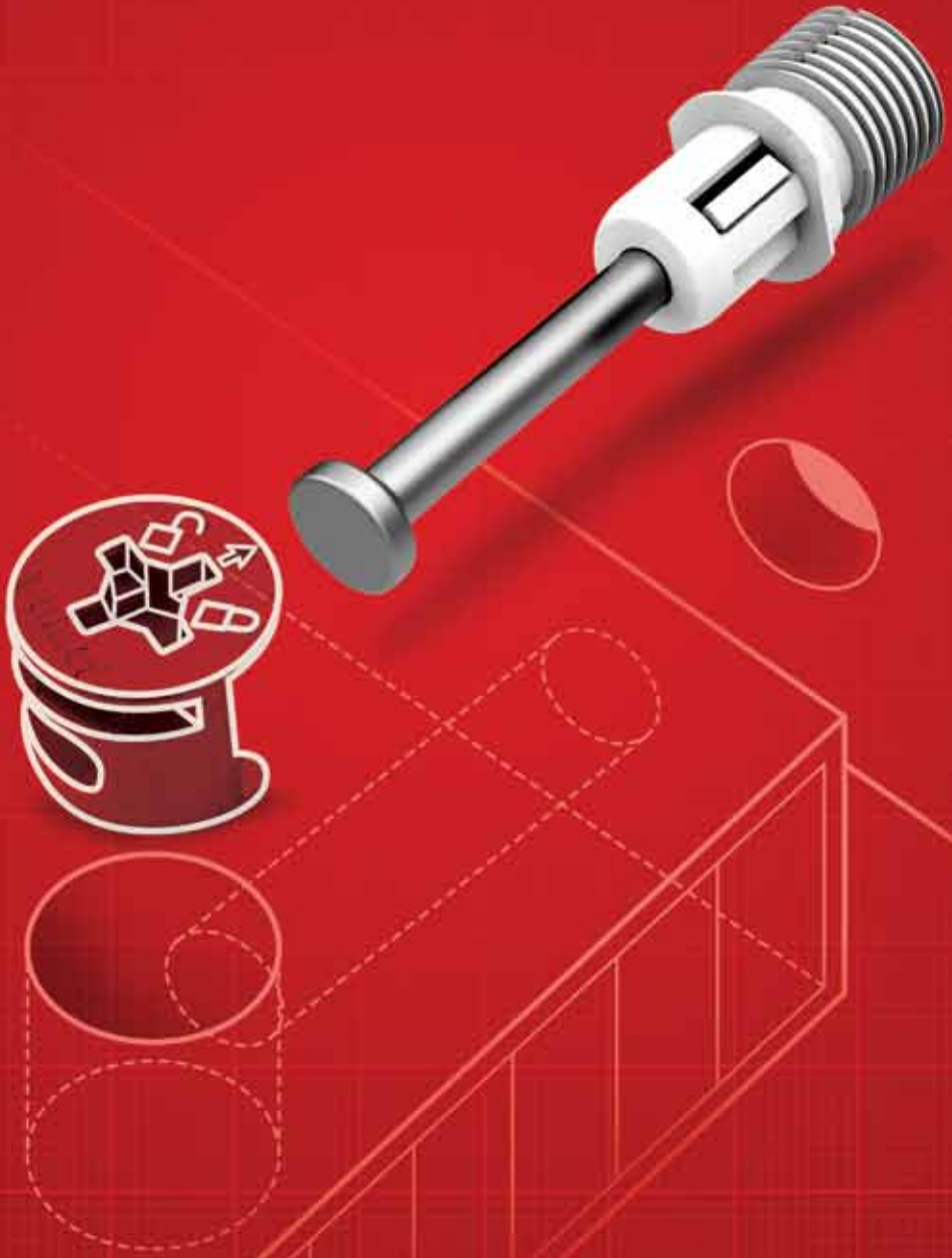



# Bağlantı

ELEMANLARI

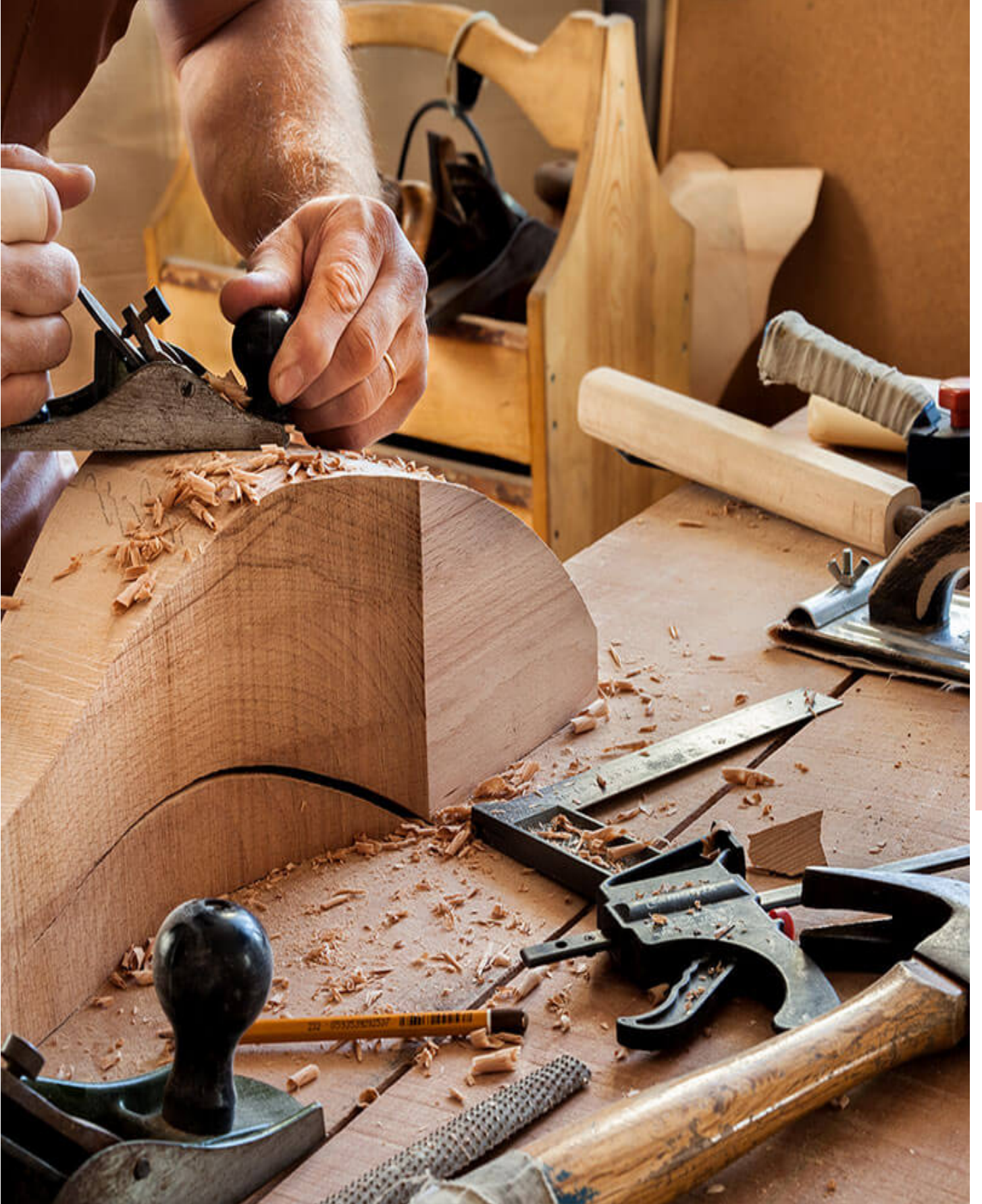



**KOD: 88901 ilke fix gövde**

NIKEL ÇİNKO

mm	mm	AÇIKLAMA	KUTU	ÇİNKO	NIKEL
L	Ø				
12	15	16 mm Sunta	1000		
13.3	15	18 mm Sunta	1000		
18	15	25 mm Sunta	1000		

Hammadde : Zamak

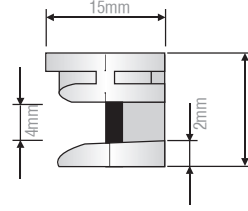

**KOD: 88905 ilke fix mili**

ÇİNKO

AÇIKLAMA	mm	mm	kg	m <sup>3</sup>	KUTU	FİYAT
Metrik Dişli	Ø 6	L 43.5	7	0.0036	1000	
Sunta Dişli	Ø 6.2	L 45.00	7	0.0036	1000	

Hammadde : Metal

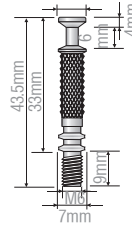

**KOD: 88902 PLASTİK ŞERİT DÜBEL**

NATUREL

mm	mm	mm	kg	m <sup>3</sup>	KUTU	FİYAT
M	Ø	L				
6	8	11	2.60	0.0082	1000	
6	10	11	2.81	0.0082	1000	
6	10	13	2.90	0.0082	1000	

Hammadde : Plastik

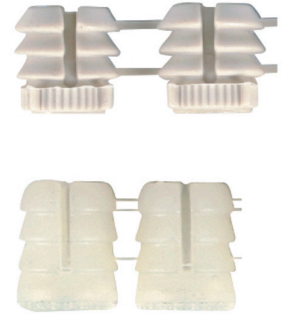
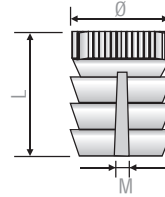

**KOD: 88910 METAL DÜBEL**

ÇİNKO

mm	mm	mm	kg	m <sup>3</sup>	KUTU	FİYAT
M	Ø	L				
6	8	10	2.80	0.0054	1000	
6	8	13	3.00	0.0054	1000	
8	10	12	3.40	0.0054	1000	
8	10	15	3.60	0.0054	1000	
8	10	18	3.80	0.0054	1000	
10	13	15	4.00	0.0054	500	

Hammadde : Zamak

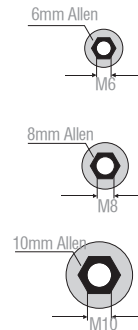



## Bağlantı Elemanları

### KOD: 88801 kendinden dübelli ilke fix mili

BEYAZ

mm Ø	mm L	kg AĞIRLIK	m <sup>3</sup>	KUTU	FİYAT
8	41	4.20	0.0032	1000	
10	41	4.67	0.0032	1000	



Hammadde : Metal+Pls

### KOD: 88807 DİKEY FİX

ÇİNKO

mm M	mm Ø	mm L	kg AĞIRLIK	m <sup>3</sup>	KUTU	FİYAT
8	7	45	20.90	0.0115	1000	

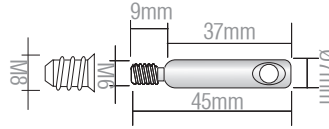

Hammadde : Zamak & Otomat

### KOD: 88808 YATAY FİX

ÇİNKO

mm M	mm Ø	mm L	kg AĞIRLIK	m <sup>3</sup>	KUTU	FİYAT
8	7	55	22.10	0.0109	1000	

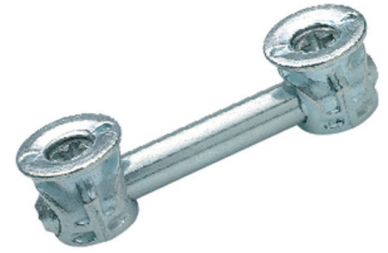
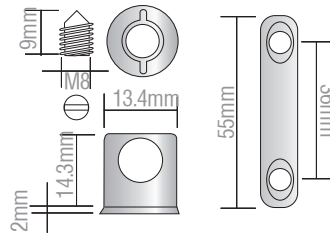

Hammadde : Zamak & Otomat

### KOD: 88001 BLUM BAĞLANTI

BEYAZ

mm Ø	mm L	kg AĞIRLIK	m <sup>3</sup>	KUTU	FİYAT
25	12	13.60	0.0019	1000	

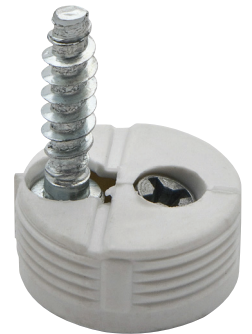
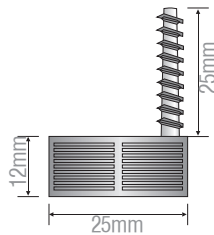

Hammadde : Metal & Plastik

### KOD: 88003 RAFİX

BEYAZ

AÇIKLAMA	mm Ø	mm L	kg AĞIRLIK	m <sup>3</sup>	KUTU	FİYAT
Sunta Diş	20	13.5	1.18	0.0054	200	

Hammadde : Metal & Plastik

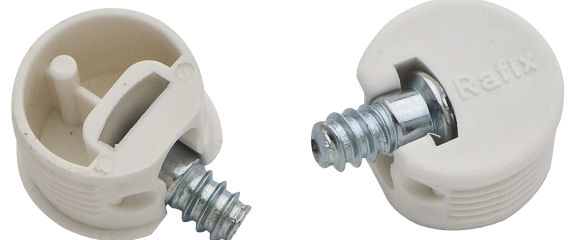



**KOD: 88701 MİNİ MONTEBENT**

NİKEL

mm	mm	kg	m <sup>3</sup>	KUTU	FİYAT
M	L	AĞIRLIK			
4	40	4.52	0.0054	500	

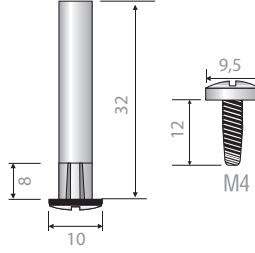

Hammadde : Metal

**KOD: 88702 METAL MONTEBENT**

ÇİNKO

mm	mm	kg	m <sup>3</sup>	KUTU	FİYAT
M	L	AĞIRLIK			
6	40	8.00	0.0054	500	
6	50	8.30	0.0034	500	
6	60	8.43	0.0054	500	
6	80	9.00	0.0054	200	

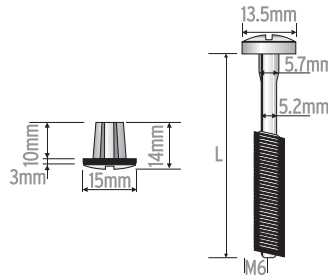

Hammadde : Metal

**KOD: 88706 SİLİNDİR ÇEKTİRME VIDALARI**

NİKEL ÇİNKO

mm	mm	ALLEN	KUTU	ÇİNKO	NİKEL
M	L				
6	15	4	1000		
6	20	4	1000		
6	25	4	1000		
6	30	4	1000		
6	35	4	1000		
6	40	4	1000		
6	45	4	1000		
6	50	4	1000		
6	55	4	1000		
6	60	4	1000		



Hammadde : Metal

**KOD: 88703 SİLİNDİR ÇEKTİRME SOMUNU**

ÇİNKO

mm	mm	mm	kg	m <sup>3</sup>	KUTU	FİYAT
M	Ø	L	AĞIRLIK			
6	10	13	4.00	0.0054	1000	
6	10	14	4.16	0.0054	1000	

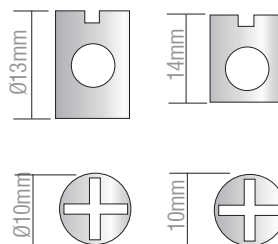

Hammadde : Zamak



## Bağlantı Elemanları

### KOD: 88302 KÖR SOMUN

ÇİNKO

mm	mm	mm	kg	m <sup>3</sup>	KUTU	FİYAT
M	Ø	L	AĞIRLIK			
6	8.8	10	6.90	0.0054	1000	

Hammadde : Otomat

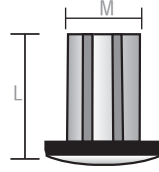

### KOD: 88304 ÇAKMA SOMUN

ÇİNKO

mm	mm	mm	kg	m <sup>3</sup>	KUTU	FİYAT
M	Ø	L	AĞIRLIK			
5/16	17	9	8.50	0.0075	1000	
6	8	9	5.20	0.0075	1000	
8	10	9	5.27	0.0075	1000	

Hammadde : Metal

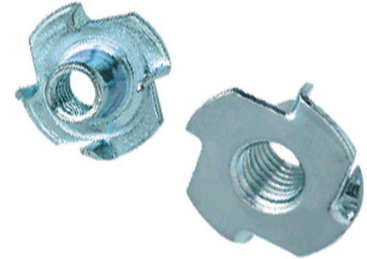
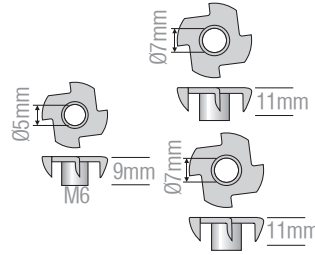

### KOD: 88710 PLASTİK VİDA PULU

mm	KUTU	KOLİ	FİYAT
Ø			
15x3,6	1000	100.000	

Hammadde : Plastik



### KOD: 88501 DEKORATİF VİDA KAPAĞI

KROM MAT KROM SATEN

mm	KUTU	FİYAT
Ø		
13	500	
15	500	
20	200	

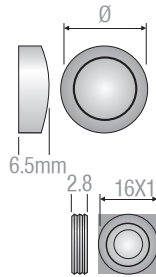

Hammadde : Zamak

### PLASTİK VİDA TAPASI

BEYAZ KREM KAHVE

KOD	AÇIKLAMA	mm	PAKET	FİYAT
		Ø		
88607	Minifix Tapası	15	1000	
88604	Kabin Vida Tapası	17	1000	
88606	10 mm Tapa	15	1000	

Hammadde : Plastik



Kabin  
88604



Minifix  
88607



10 mm Tapa  
88606



**KOD: 88909** N04 KASA BAĞLANTI DÜBEL TAKIMI

GRİ

**KUTU FİYAT**

200 Tk.

Hammadde : Plastik & Metal



**KOD: 88910** N08 KASA BAĞLANTI DÜBEL TAKIMI

GRİ

**KUTU FİYAT**

200 Tk.

Hammadde : Plastik & Metal



**KOD: 88911** N09 KASA BAĞLANTI DÜBEL TAKIMI

GRİ

**KUTU FİYAT**

200 Tk.

Hammadde : Plastik & Metal



**KOD: 88912** N10 KASA BAĞLANTI DÜBEL TAKIMI

GRİ

**KUTU FİYAT**

200 Tk.

Hammadde : Plastik & Metal



**KOD: 88913** G08 KASA BAĞLANTI DÜBEL TAKIMI

GRİ

**KUTU FİYAT**

200 Tk.

Hammadde : Plastik & Metal





## YAPIŞKANLI VİDA TAPALARI

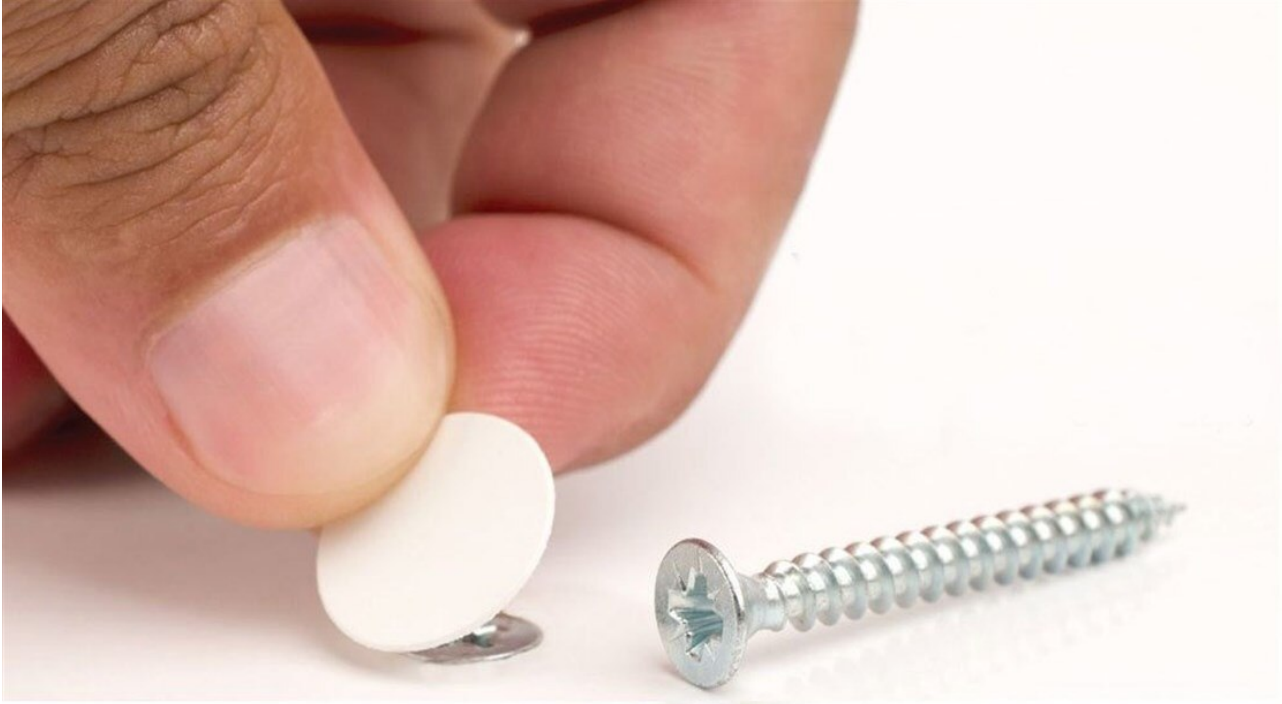

*En iyi teknolojilerin, kaliteli hammaddelerle birleştirilmesi sonucu PVC folyo malzemesinden üretilen, Yapışkanlı Vida Tapalarımızı üretmekteyiz. Yapışkanlı Vida Tapalarımız, standart olarak Ø14mm ve Ø 18mm ebatlarındadır. Mobilya sektöründeki gelişmeler ışığında her geçen gün büyüyen renk ve desen skalamız, müşterilerimizin beklentilerini karşılamak ve onlara en üstün kaliteyi sunmak için hassasiyetle geliştirilmektedir. Ayrıca, müşterilerimizin istek ve beklentileri doğrultusunda farklı boy ve desenlerde tapa üretimimiz de mevcut.*



## Yapışkan Tapalar

**KOD: 88602 Ø 14 - YAPIŞKAN TAPA 0,18 MM**



mm Ø	mm H	1 PLAKA	KUTU	FİYAT
14	0,18	50 Ad	50 Plk.	

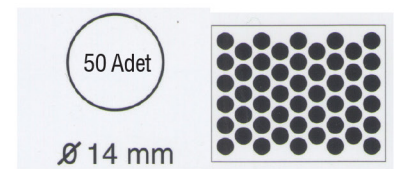
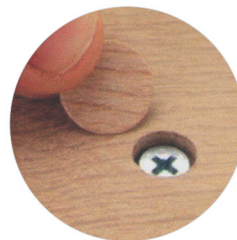

Hammedde : PVC



**KOD: 88609** Ø 18 - YAPIŞKAN TAPA 0,22 MM



mm Ø	mm H	1 PLAKA	KUTU	FİYAT
18	0,22	32 Ad	50 Plk.	

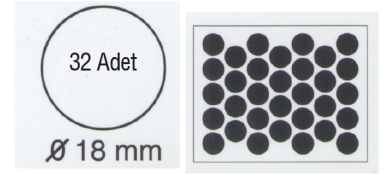
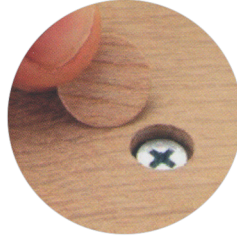

Hammedde : PVC

**KOD: 34608** HIGHGLASS YAPIŞKAN TAPA

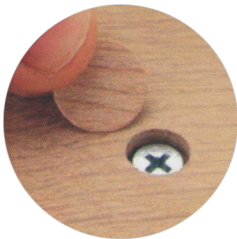

mm Ø	mm H	1 PLAKA	KUTU	FİYAT
14	0,22	50 Ad	50 Plk.	
18	0,22	32 Ad	50 Plk.	

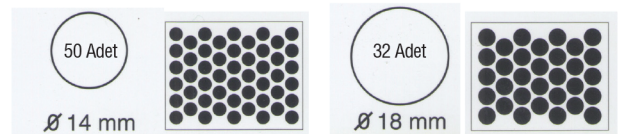

Hammedde : PVC

## YAPIŞKANLI KEÇE ZEMİN KORUYUCULARI



***Pek çok farklı şekil ve ebatta Sentetik Keçe malzemesinden ürettiğimiz Yapışkanlı Keçe Zemin Koruyucularımız, güçlü tutkalı ve zeminin çizilmesini önleyici özellikleriyle bilinmektedir. Farklı alanlar ve mobilyalar için farklı renklerde ürettiğimiz Yapışkanlı Keçe Zemin Koruyucularımız, mobilya ve zeminlere uyum sağlamak ve onları korumak konusunda üstün performans sergilemektedir.***



## Koruyucu Aksesuarlar

### KOD: 88401 SES STOPERİ

ŞEFFAF

mm Ø	mm L	1 PLAKA	KUTU	FİYAT
9	2.0	50 Ad	100 Plk.	
10	1.6	50 Ad	100 Plk.	

Hammadde : Silikon

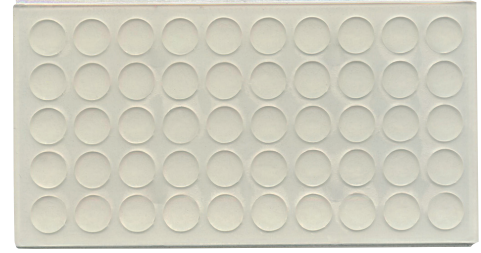

### KOD: 88501 ŞEFFAF CAM TUTUCU

ŞEFFAF

mm Ø	mm L	1 PLAKA	KUTU	FİYAT
14	2.0	28 Ad	25 Plk	
18	3.8	12 Ad	25 Plk	
22	2.0	15 Ad	25 Plk	

Hammadde : Silikon

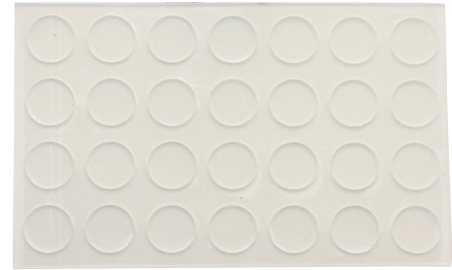

### KOD: 88403 EVA CAM MASA ALTLIĞI

GRI SİYAH BEYAZ KREM

mm Ø	mm L	1 PLAKA	KUTU	FİYAT
10	2	50 Ad.	25 Plk.	

Hammadde : Eva

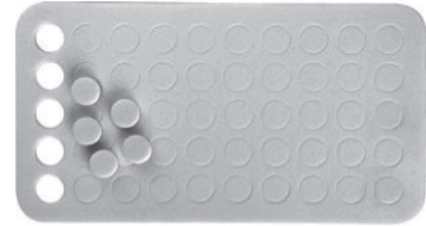

### KOD: 88301 YUVARLAK ZEMİN KORUYUCU YAPIŞKAN KEÇE

SİYAH KAHVE

mm Ø	1 PLAKA	KUTU	FİYAT
20	48 Ad	50 Plk.	
24	33 Ad	50 Plk.	
28	28 Ad	50 Plk.	
35	18 Ad	50 Plk.	
40	12 Ad	50 Plk.	
45	10 Ad	50 Plk.	

Hammadde : Keçe

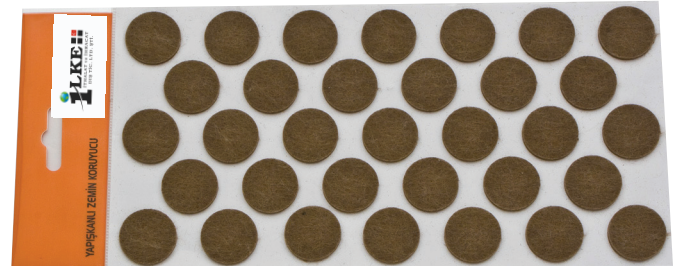

### KOD: 88302 KARE ZEMİN KORUYUCU YAPIŞKAN KEÇE

SİYAH KAHVE

mm □	1 PLAKA	KUTU	FİYAT
20 x 20	50 Ad	50 Plk.	
25 x 25	32 Ad	50 Plk.	
30 x 30	21 Ad	50 Plk.	
35 x 35	18 Ad	50 Plk.	
40 x 40	10 Ad	50 Plk.	
35 x 55	12 Ad	50 Plk.	
40 x 90	5 Ad	50 Plk.	
120 x 240	1 Ad	50 Plk.	

Hammadde : Keçe

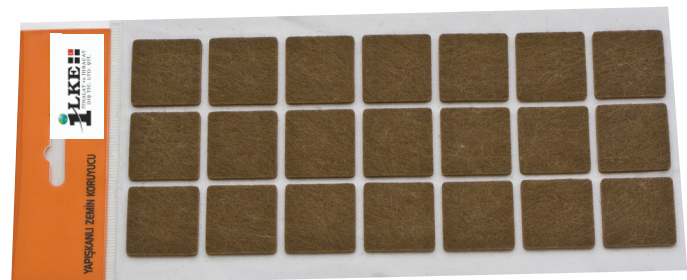

# MASA APARATLARI

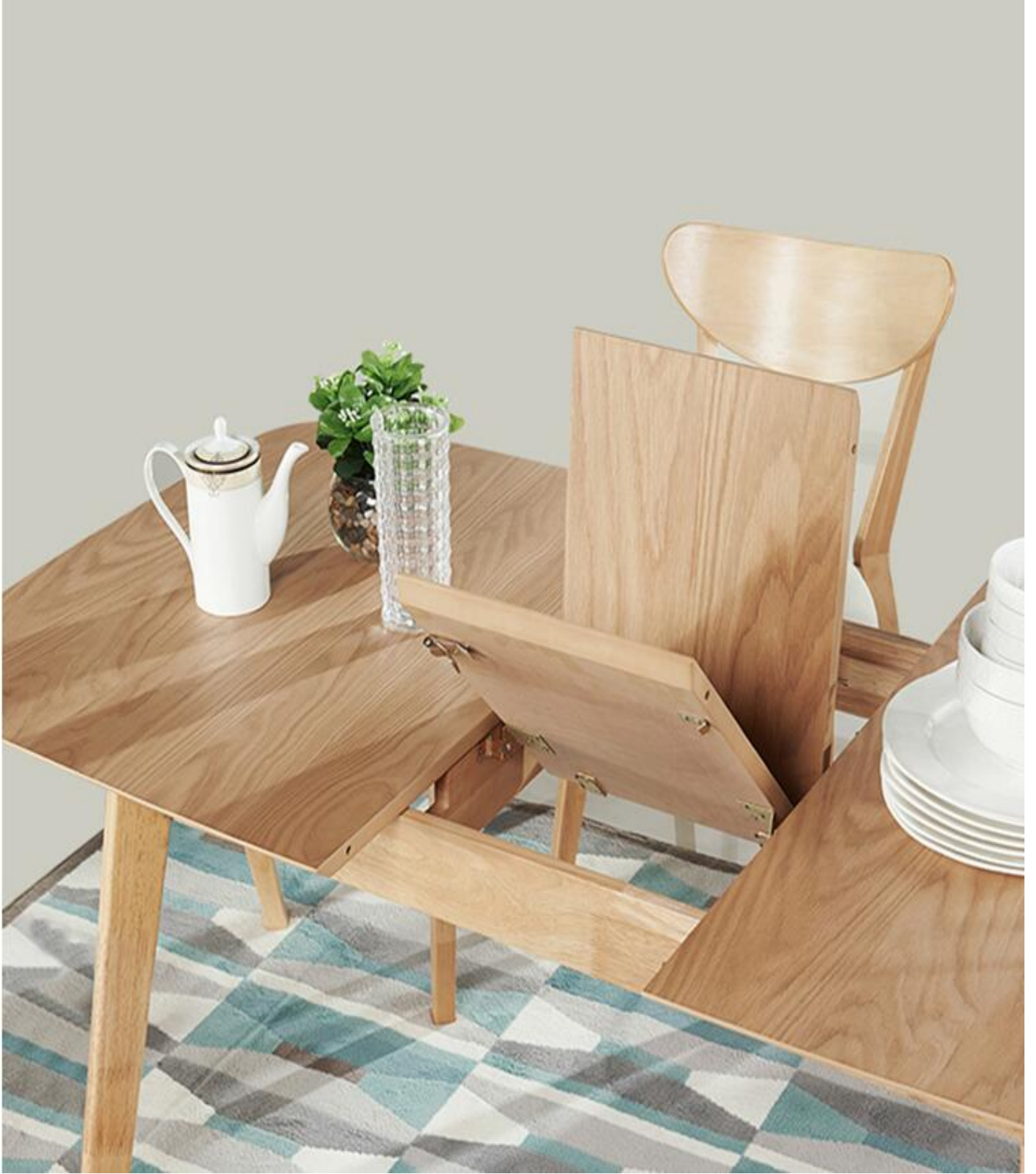



## Masa Bağlantı Elemanları

### KOD: 88943 MASA İLAVE APARATI TAKIMI (ORTA KAPAK)

ÇİNKÖ



KUTU	FİYAT
------	-------

50 Tk.

Hammadde : Metal+Plastik

### KOD: 88942 MASA TABLA DESTEK MAKARASI

GİRİ



KUTU	FİYAT
------	-------

100

Hammadde : Plastik & Otomat

### KOD: 88939 SİLİNDİR MASA MENTEŞESİ

SARI

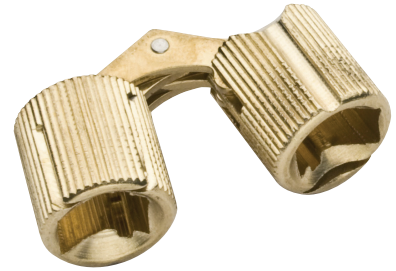

mm Ø	KUTU	FİYAT
10	100	
12	100	
14	50	
16	50	

Hammadde : Piring

### KOD: 88409 KIRMA MASA MENTEŞESİ

KAHVE

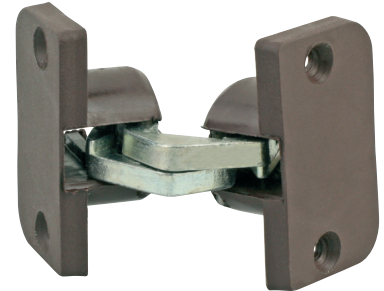

AĞIRLIK kg	KUTU	FİYAT
1.69	50	

Hammadde : Plastik & Zamak

**KOD: 88940 KIRMA MASA MENTEŐESİ (OVAL)**

BEYAZ  KAHVE

AÇIKLAMA	KUTU	FİYAT
12 mm	50	

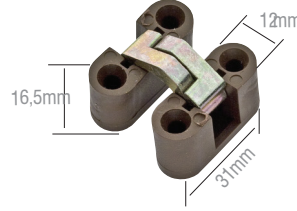

Hammadde : Plastik & Zamak

**KOD: 88941 KIRMA MASA SABİTLEME**

BEYAZ  KAHVE

RENK	KUTU	FİYAT
Beyaz	100	
Kahve	100	

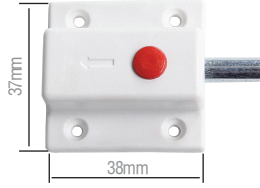

Hammadde : Plastik & Otomat

**KOD: 88317 KABLO KANALI YUVARLAK**

BEYAZ  KAHVE  KREM  GRİ  SİYAH

mm	mm	kg	KUTU	FİYAT
Ø	H	AĞIRLIK		
60	24	0.36	50	



Hammadde : Plastik

● Opsiyonel Renklerde Minimum Sipariő 500 Adettir.

**KOD: 2660 PLASTİK SOFRA AYAęI**

SİYAH  BEYAZ

mm	mm	kg	KUTU	FİYAT
L	L1	AĞIRLIK		
230	140	11	100	

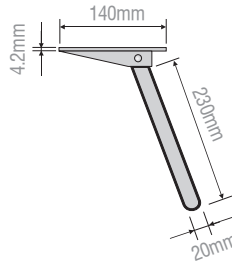

Hammadde : Plastik

**KOD: 2661 METAL SOFRA AYAęI**

ÇİNKO

cm	cm	KUTU	FİYAT
Ø	L		
20x20	20	100	
20x20	25	100	

Hammadde : Metal





**KAPI VE BAZA**  
**FİTİLLERİ**

İstenileni



## Kapı ve Baza Fitilleri

### KOD: 88360 KAPI FiTİLi

BEYAZ  KREM  KAHVE  MEŞE  ŞEFFAF

KOD	ÖLÇÜ <sup>mm</sup>	PAKET/Mt	KOLİ/Mt	RENKLİ FİYAT / MT	ŞEFFAF FİYAT / MT
6036008	8 mm	100	600		
6036010	10 mm	100	600		
6036012	12 mm	100	600		



### KOD: 88365 KAPI FiTİLi

BEYAZ  KREM  KAHVE  MEŞE  ŞEFFAF

KOD	ÖLÇÜ <sup>mm</sup>	PAKET/Mt	KOLİ/Mt	RENKLİ FİYAT / MT	ŞEFFAF FİYAT / MT
6036508	8 mm	100	600		
6036510	10 mm	100	600		
6036512	12 mm	100	600		



### KOD: 88370 KAPI FiTİLi

BEYAZ  KREM  KAHVE  MEŞE  ŞEFFAF

KOD	ÖLÇÜ <sup>mm</sup>	PAKET/Mt	KOLİ/Mt	RENKLİ FİYAT / MT	ŞEFFAF FİYAT / MT
6037008	8 mm	100	600		
6037010	10 mm	100	600		
6037012	12 mm	100	600		



### KOD: 88375 KAPI FiTİLi

BEYAZ  KREM  KAHVE  MEŞE  ŞEFFAF

KOD	ÖLÇÜ <sup>mm</sup>	PAKET/Mt	KOLİ/Mt	RENKLİ FİYAT / MT	ŞEFFAF FİYAT / MT
6037508	8 mm	100	600		
6037510	10 mm	100	600		
6037512	12 mm	100	600		



### KOD: 88378 KAPI FiTİLi

BEYAZ  KREM  KAHVE  MEŞE  ŞEFFAF

KOD	ÖLÇÜ <sup>mm</sup>	PAKET/Mt	KOLİ/Mt	RENKLİ FİYAT / MT	ŞEFFAF FİYAT / MT
6037810	10 mm	100	600		





**KOD: 88362 KAPI FiTiLi CO-EX**

BEYAZ  KREM  KAHVE  MEŞE  ŞEFFAF

ÖLÇÜ <sup>mm</sup>	PAKET/Mt	KOLİ/Mt	RENKLİ FİYAT / MT	ŞEFFAF FİYAT / MT
10 mm	1000	1000		

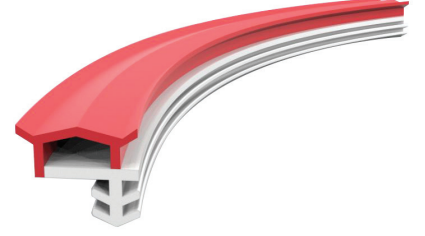

**KOD: 88250 BAZA FiTiLi**

ŞEFFAF

PAKET / MT	FİYAT / MT
100	

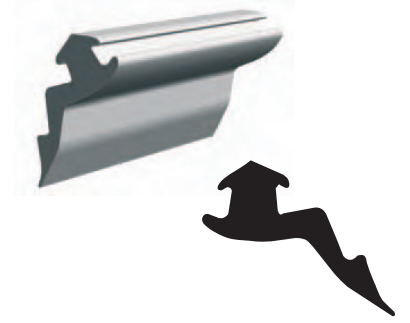

**KOD: 88235 CAM FiTiLi**

ŞEFFAF

PAKET / MT	FİYAT / MT
100	

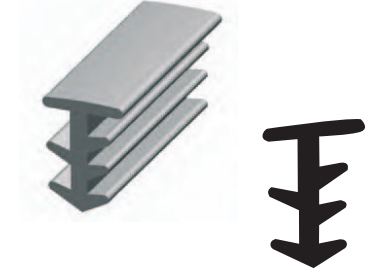

**KOD: 88220 STOP FiTiLi**

METALİK

PAKET / MT	FİYAT / MT
100	

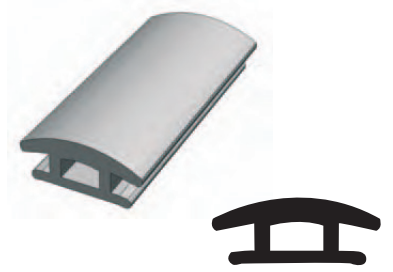

**KOD: 88225 STOP FiTiLi (Küçük)**

METALİK

PAKET / MT	FİYAT / MT
100	

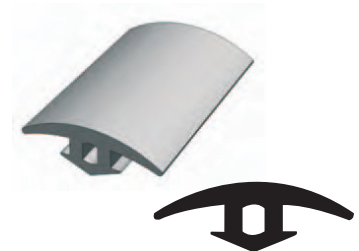

# KARYOLA VE BEŐİK AKSESUARLARI





## Karyola ve Beşik Aksesuarları

### KOD: 88703 DÜBELLİ KARYOLA DEMİRİ

ÇİNKO



1 Takım: 4 Adet

AÇIKLAMA	mm L	mm G	mm H	KG	KUTU	FİYAT/ TAKIM
1.2 mm	128	25	25	3,10	10 Tk.	

Hammadde : Metal

### KOD: 88817 DÜBELSİZ KARYOLA DEMİRİ

ÇİNKO



AÇIKLAMA	mm L	mm G	mm H	KG	KUTU	FİYAT
1.2 mm	128	25	25	3	50	

Hammadde : Metal

### KOD: 88704 KARYOLA DEMİRİ TIRNAKLI

SARI



KUTU	FİYAT
10 Tk.	

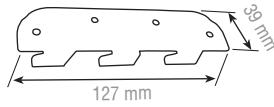

Hammadde : Metal

1 TK / 4 Alt - 4 Üst

### KOD: 88729 KARYOLA DEMİRİ DÜZ

SARI



AÇIKLAMA	KUTU	FİYAT
9 cm Üç Delikli	10 Tk.	
12,5 cm Üç Delikli	10 Tk.	
15 Cm Dört Delikli	10 Tk.	

Hammadde : Metal

1 TK / 4 Alt - 4 Üst

### KOD: 88103 BEŞİK MEKANİZMASI

KROM



cm L	KUTU	FİYAT
80	25	

Hammadde : Metal

### KOD: 88101 BEŞİK APARATI

SİYAH

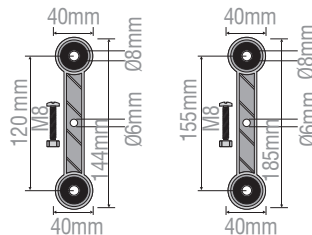

mm L	mm G	mm H	kg AĞIRLIK	m <sup>3</sup>	KUTU	FİYAT ADET
120	40	15	2.00	0.0054	20	
155	40	15	2.25	0.0054	20	

Hammadde : Plastik & Rulman

# KİLİT VE AKSESUARLARI





**KOD: 880427 KARE ÇEKMECE KİLİDİ YAYLI DİL**

KROM



KUTU	FİYAT
12	

Hammadde : Zamak

**KARE ÇEKMECE KİLİDİ**

KROM



KOD	AÇIKLAMA	KUTU	FİYAT
390425	Sac	12 Ad.	
390422	Zamak	12 Ad.	

Hammadde : Sac

Hammadde : Zamak

**KOD: 880423 OVAL ÇEKMECE KİLİDİ**

KROM

KUTU	FİYAT
12	

Hammadde : Zamak



**KOD: 880426 MERKEZİ KESON KİLİDİ**

ÇİNKO



KOD	AÇIKLAMA	KUTU	FİYAT
16-50-K	50 CM SET GÖBEK ÇAPI 16 MM	12	
16-70-K	70 CM SET GÖBEK ÇAPI 16 MM	12	
19-70-K	70 CM SET GÖBEK ÇAPI 19 MM	12	

KATLANIR ANAHTARLI

Hammadde : Zamak

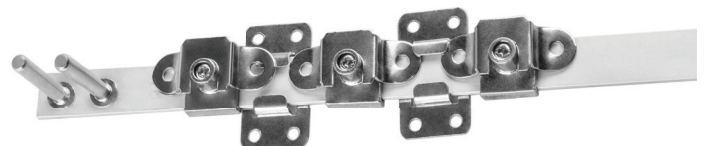

## Çekmece Kilit ve Aksesuarları

### KOD: 880410 CAM KİLİDİ SÜRGÜLÜ

KROM

AÇIKLAMA	KUTU	FİYAT
CAM KİLİDİ 140 MM	12	

Hammadde : Sac



### KOD: 880408 CAM KİLİDİ TEK KANAT

KROM

KUTU	FİYAT
12	

Hammadde : Zamak



### KOD: 880409 CAM KİLİDİ ÇİFT KANAT

KROM

KUTU	FİYAT
12	

Hammadde : Zamak



### KOD: 880424 ÇEKMECE KİLİT KARŞILIĞI

ÇİNKO

KUTU	FİYAT
500	

Hammadde : Metal



### KOD: 88953 ÇEKMECE RAYI STANDART

BEYAZ

ÖLÇÜ <sup>cm</sup>	KUTU	FİYAT TK.
25	25 Tk.	
30	25 Tk.	
35	25 Tk.	
40	25 Tk.	
45	25 Tk.	
50	25 Tk.	
55	25 Tk.	
60	25 Tk.	

Hammadde : Metal





# DOLAP BAĞLANTI ELEMENLARI



Baza Bağlantı Elemanları

**KOD: 88402 VAZO AYAK SACI**

ÇİNKO

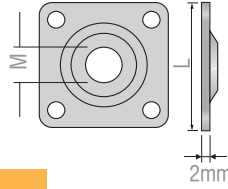

AÇIKLAMA	mm M	mm L	mm G	kg AĞIRLIK	m <sup>3</sup>	KUTU	FİYAT
2 mm	8	50	50	7.10	0.0054	250	
2 mm	10	50	50	7.10	0.0054	250	

Hammadde : Metal

**KOD: 88703 METAL AYAK ARA BAĞLANTI PULU**

ÇİNKO

AÇIKLAMA	mm Ø	mm L	kg AĞIRLIK	m <sup>3</sup>	KUTU	FİYAT
2 mm	42	10	3.62	0.0054	200	
2 mm	60	10	4.00	0.0054	200	

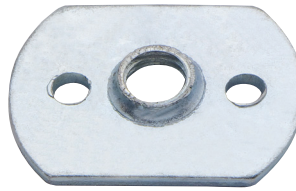

42 mm



60 mm

Hammadde : Metal

**KOD: 88910 BAĞLANTI SACI**

ÇİNKO

KUTU	FİYAT TK.
50 Tk.	

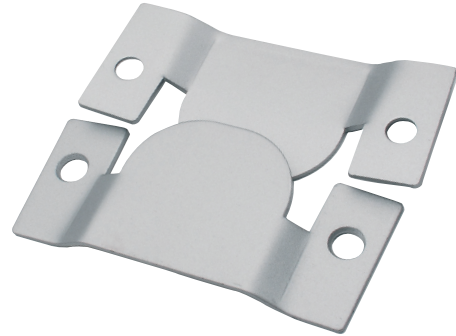
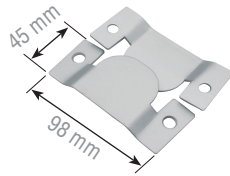

Hammadde : Metal

**KOD: 88702 KARE METAL TV ALTIĞI**

ÇİNKO

mm L	mm G	mm H	KUTU	FİYAT
150	150	10	10	



Hammadde : Metal

**KOD: 88706 BANYO DOLAP ASKI ELEMANI**

ÇİNKO

AÇIKLAMA	mm L	mm G	mm H	kg AĞIRLIK	m <sup>3</sup>	KUTU	FİYAT
1.5 mm	50	36	24	25	0.011	50	



Hammadde : Metal



## Dolap Bağlantı Elemanları

### KOD: 34801 ÇİVİLİ POLİGRİT

BEYAZ  KAHVE  ŞEFFAF  SİYAH

mm Ø	mm H	kg AĞIRLIK	m <sup>3</sup>	KUTU	PLASTİK RENKLER	ŞEFFAF
16	5	4	0.0079	5000		

Hammadde : Metal+Pls.

● Opsiyonel Renklerde Minimum Sipariş 25.000 Adettir. Termin süresi 15 gündür.



### KIRLANGIÇ BAĞLANTI

BEYAZ

KOD	AÇIKLAMA	kg AĞIRLIK	m <sup>3</sup>	KUTU	FİYAT
34901	Kırlangıç	1.20	0.0036	3000	
34907	H Kırlangıç	1.20	0.0036	2000	

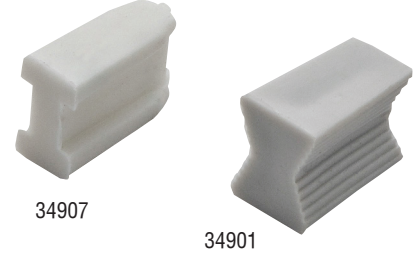
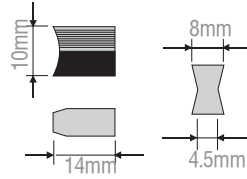

Hammadde : Plastik

● Opsiyonel Renklerde Minimum Sipariş 30.000 Adettir. Termin süresi 15 gündür.

### KOD: 34904 PLS. ARKALIK SIKIŞTIRICI

BEYAZ  SİYAH

kg AĞIRLIK	m <sup>3</sup>	KUTU	FİYAT
1.16	0.0054	2000	

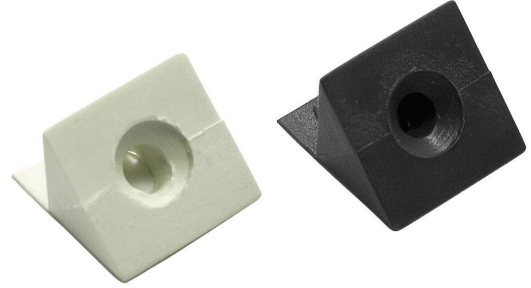
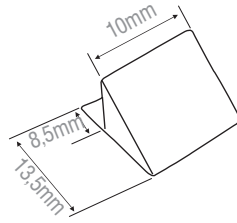

Hammadde : Plastik

### KOD: 34502 AHŞAP KAVALYE

AHŞAP

mm Ø	mm L	kg AĞIRLIK	ÇUVAL	FİYAT/KG
8	30	20	20 kg.	
8	35	20	20 kg.	
10	35	20	20 kg.	

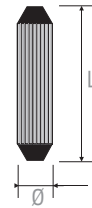

Hammadde : Ahşap

### KOD: 34501 PLASTİK KAVALYE

SİYAH  BEYAZ

mm Ø	mm L	kg AĞIRLIK	m <sup>3</sup>	KUTU	SİYAH	BEYAZ
8	30	5.45	0.019	5000		

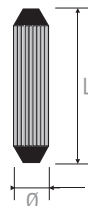

Hammadde : Plastik

**KOD: 33331 AÇILI ŐEFFAF ÇEKTİRME**

ŞEFFAF BEYAZ



kg	KUTU	FİYAT
1.10	100	

Hammadde : Kırılmaz Cam+Metal

**KOD: 33334 AÇILI METAL ÇEKTİRME**

NİKEL ÇİNKO



KUTU	ÇİNKO	NİKEL
100		

Hammadde : Zamak

**KOD: 32905 APEX AÇILI BAĐLANTI**

NİKEL ÇİNKO



mm	mm	mm	kg	m <sup>3</sup>	KUTU	ÇİNKO/SARI	NİKEL
L	G	H	AĐIRLIK				
37	17	15	2.58	0.0058	300		

Hammadde : Zamak

**KOD: 32904 TE BAĐLANTI**

NİKEL ÇİNKO

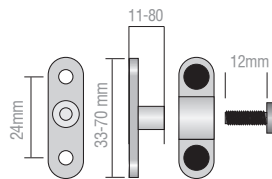

mm	mm	mm	kg	m <sup>3</sup>	KUTU	ÇİNKO/SARI	NİKEL
L	G	H	AĐIRLIK				
36	12	15	2.58	0.0058	300		

Hammadde : Zamak



## Dolap Bağlantı Elemanları

### KOD: 32914 PLASTİK TIRNAKLI ÇEKTİRME

BEYAZ

mm	mm	mm	kg	m <sup>3</sup>	KUTU	FİYAT
L	G	H	AĞIRLIK			
39	14	20	1.72	0.0036	100	

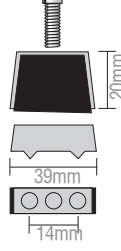

Hammadde : Metal & Plastik

### KOD: 34903 PLASTİK L KÖŞE

BEYAZ  KAHVE  KREM  SİYAH

mm	mm	kg	m <sup>3</sup>	KUTU	FİYAT
L	H	AĞIRLIK			
27	27	1.24	0.0054	250	



Hammadde : Plastik

● Opsiyonel Renklerde Minimum Sipariş 25.000 Adettir. Termin süresi 15 gündür.

### KOD: 34902 PLASTİK L KÖŞE KAPAKLI

BEYAZ

mm	mm	mm	kg	m <sup>3</sup>	KUTU	FİYAT
L	G	H	AĞIRLIK			
36	27	13.5	1.46	0.0079	300	

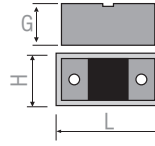

Hammadde : Plastik

● Opsiyonel Renklerde Minimum Sipariş 25.000 Adettir. Termin süresi 15 gündür.

### KOD: 34909 PLASTİK KAPAKSIZ KÖŞE BAĞLANTI

BEYAZ  KAHVE

KUTU	FİYAT
250	



Hammadde : Plastik

### KOD: 3751 AYAKKABILIK

BEYAZ

AÇIKLAMA	mm	mm	kg	m <sup>3</sup>	KUTU	FİYAT
	L	G	AĞIRLIK			
2'li Ayakkabılık	258	202	6.40	0.048	25	

Hammadde : Plastik



**KOD: 34701 DOLAP ASKI ELEMANI**

BEYAZ  KREM

AÇIKLAMA	mm L	mm G	mm H	kg AĞIRLIK	m <sup>3</sup>	KUTU	FİYAT
1.2 mm	46	41	31	8	0.011	250	
1.5 mm	46	41	31	9.4	0.011	250	

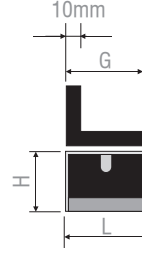

Hammadde : Metal & Plastik

**KOD: 34712 PLASTİK KAPAKLI METAL GÖNYE**

BEYAZ

mm L	mm G	mm H	KUTU	FİYAT
35	40	40	150	

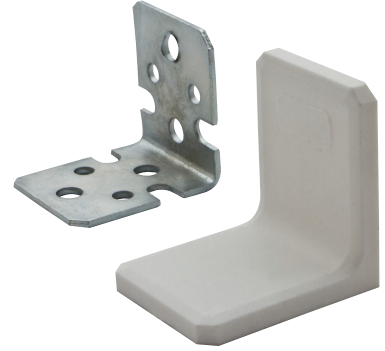

Hammadde : Metal & Plastik

**KOD: 34705 DASET ASKI ELEMANI**

BEYAZ

KOD	AÇIKLAMA	mm L	mm G	mm H	kg AĞIRLIK	m <sup>3</sup>	KUTU	FİYAT
34705	Askı Elemanı	60	19	42	5.74	0.010	100	
3470932	Beyaz Kapak	61	20	43	1.00	0.0054	100	



Hammadde : Metal+Pls

**KOD: 34707 ASKI KANCASI**

ÇİNKO

AÇIKLAMA	mm Ø	mm L	kg AĞIRLIK	m <sup>3</sup>	KUTU	FİYAT
L Vida	6	60	2.16	0.0016	200	

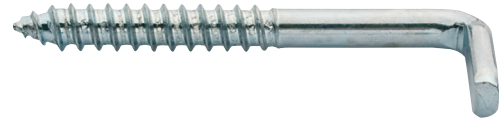

Hammadde : Metal

**KOD: 34708 ASKI SACI**

ÇİNKO

AÇIKLAMA	mm L	mm G	m <sup>3</sup>	KUTU	FİYAT
2 mm	104	37	0.0054	300	

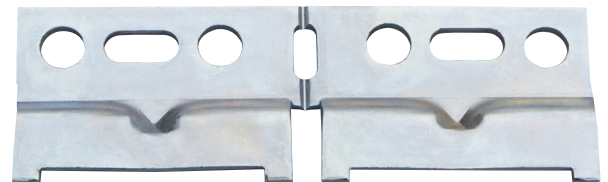

Hammadde : Metal



## Dolap Bağlantı Elemanları

### DOLAP TAS MENTEŞE

AÇIKLAMA	AÇIKLAMA	KUTU	FİYAT
39222	Dolap Tas Menteşe Düz	250	Fiyat Sorunuz
39224	Dolap Tas Menteşe Deve Boynu	250	
39223	Dolap Tas Menteşe Süper Deve Boynu	250	



Hammadde : Sac

### DOLAP TAS MENTEŞE FRENLI

AÇIKLAMA	AÇIKLAMA	KUTU	FİYAT
39219	Dolap Tas Menteşe Frenli Düz	100	Fiyat Sorunuz
39220	Dolap Tas Menteşe Frenli Deve Boynu	100	
39221	Dolap Tas Menteşe Frenli Süper Deve Boynu	100	

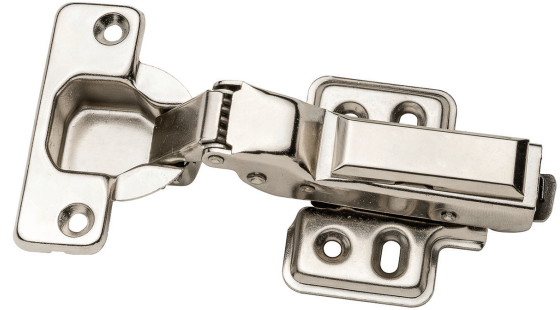

Hammadde : Sac

### KAPAK MEKANİZMASI

GRİ

KUTU	FİYAT
50	

Kod: 37010

30x90	■
30x100	■
30x110	■
30x120	■
35x70	■
35x75	■
35x80	■
35x85	■
35x90	■
40x50	■
40x60	■
40x70	■
40x110	■
40x120	■
40x130	■
40x140	■
35-40x150	■
35-40x160	■

Kod: 37011

30x50	■
30x60	■
30x70	■
30x80	■
30x130-160	■
35x50	■
35x60	■
35x100	■
35x110	■
35x120	■
35x130	■
35x140	■
40x75	■
40x80	■
40x90	■
40x100	■

Hammadde : Plastik



### KOD: 370011 AYARLI KAPAK MAKASI METAL

NİKEL

KUTU	FİYAT
25	



Hammadde : Zamak+Metal

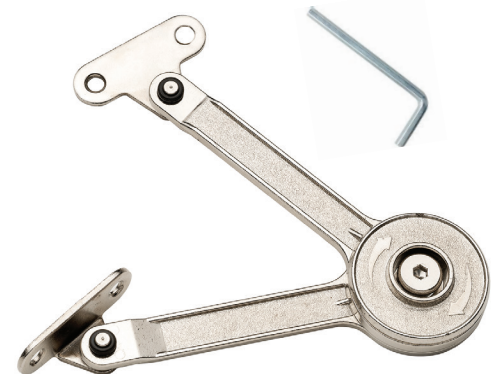

**KOD: 37014 AYARLI KAPAK MAKASI ŞEFFAF**

ŞEFFAF

KUTU	FİYAT
10	

Hammadde : Kırılmaz Cam Şeffaf



**KOD: 37003 KALKAR KAPAK MAKASI**

ÇİNKO

cm L	kg AĞIRLIK	m <sup>3</sup> KUTU	FİYAT
15	1.00	0.0015	20
20	1.20	0.0015	20
25	1.40	0.0017	20
30	1.50	0.0020	20

Hammadde : Metal

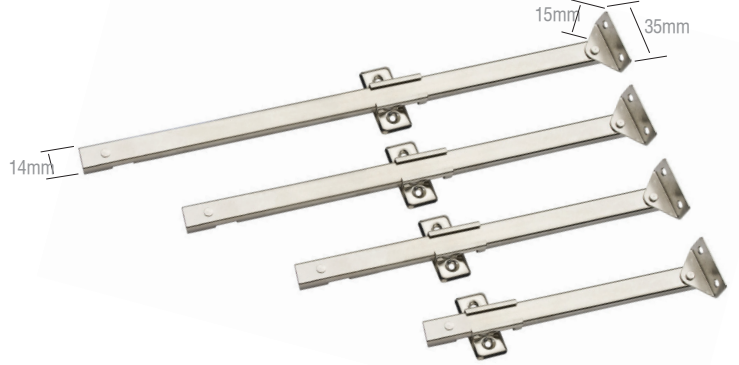

**KOD: 37004 FRENLİ KAPAK MAKASI**

BEYAZ (Pls) KAHVE (Pls)

cm L	kg AĞIRLIK	m <sup>3</sup> KUTU	FİYAT
25	4.75	0.011	100

Hammadde : Metal+Pls.

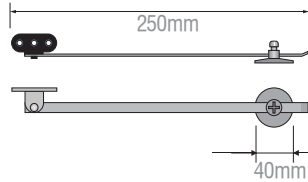

**KOD: 37006 GAZLI KAPAK AMORTİSÖRÜ (İthal)**

AÇIKLAMA	kg AĞIRLIK	m <sup>3</sup> KUTU	FİYAT
60 N	14	0.020	100
80 N	14	0.020	100
100 N	14	0.020	100
120 N	14	0.020	100

Hammadde : Metal+Pls.

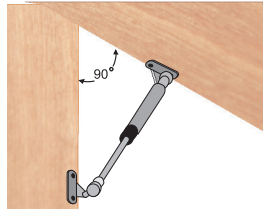

**KOD: 37012 GAZLI KAPAK AMORTİSÖRÜ FRENLI**

KUTU	FİYAT
100	

Hammadde : Metal+Pls.





## Dolap Bağlantı Elemanları

### KOD: 33327 YUVARLAK ŞEFFAF FLANŞ

ŞEFFAF

AĞIRLIK	KUTU	FİYAT
1.64	100	

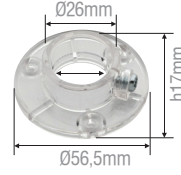

Hammadde : Şeffaf Kırılmaz Cam

### DAİRE FLANŞ

KROM

KOD	AÇIKLAMA	mm	mm	AĞIRLIK	m <sup>3</sup>	KUTU	FİYAT
33001	Düz	50	26	1.05	0.0054	100	
33002	Vidalı	50	26	1.40	0.0054	100	

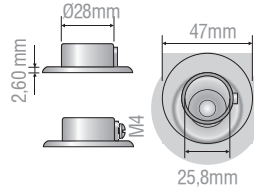

Hammadde : Zamak

### KOD: 33021 DAİRE FLANŞ MINI

KROM

mm	KUTU	FİYAT
16	250	



Hammadde : Zamak

### KOD: 33020 ÜÇGEN FLANŞ

KROM

AÇIKLAMA	mm	KUTU	FİYAT
Düz	25	250	
Vidalı	25	250	



Hammadde : Zamak

**KOD: 33003 İÇİ METAL KAPAKLI FLANŞ**

KROM

mm	mm	kg	m <sup>3</sup>	KUTU	FİYAT
DİŞ Ø	İÇ Ø	AĞIRLIK			
38.5	26	2.90	0.0054	75	

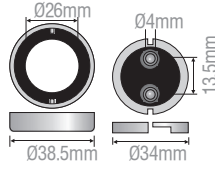

Hammadde : Zamak

**KOD: 33004 İÇİ PLASTİK KAPAKLI FLANŞ**

KROM

mm	mm	kg	m <sup>3</sup>	KUTU	FİYAT
DİŞ Ø	İÇ Ø	AĞIRLIK			
38.5	26	1.90	0.0054	75	

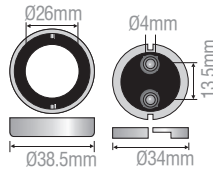

Hammadde : Zamak & Plastik

**KOD: 33014 GÖKÇE FLANŞ**

KROM NİKEL

mm	mm	KUTU	FİYAT
DİŞ Ø	İÇ Ø		
40	26	200	

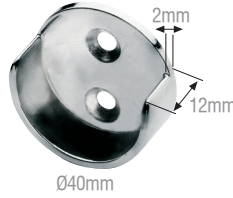

Hammadde : Zamak

**KOD: 33010 L BORU FLANŞI**

KROM

mm	kg	m <sup>3</sup>	KUTU	FİYAT
İÇ Ø	AĞIRLIK			
26	2.67	0.0054	40	



Hammadde : Zamak

**KOD: 33009 T BORU FLANŞI**

KROM

mm	kg	m <sup>3</sup>	KUTU	FİYAT
İÇ Ø	AĞIRLIK			
26	3	0.0054	40	

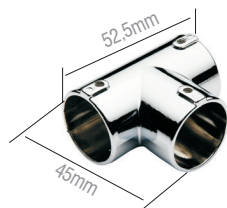

Hammadde : Zamak



## Dolap Bağlantı Elemanları

### KOD: 33022 3'lü BORU FLANŞI

KROM

mm İÇ Ø	KUTU	FİYAT
25	30	

Hammadde : Zamak



### KOD: 33023 4'lü BORU FLANŞI

KROM

mm İÇ Ø	KUTU	FİYAT
25	30	

Hammadde : Zamak



### KOD: 33201 DAİRE BORU TUTUCU AÇIK

KROM

mm DİŞ Ø	mm İÇ Ø	mm H	kg AĞIRLIK	m <sup>3</sup>	KUTU	FİYAT
40	26	70	2.24	0.0054	50	

Hammadde : Zamak

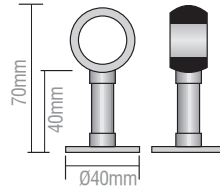

### KOD: 33202 DAİRE BORU TUTUCU KAPALI

KROM

mm DİŞ Ø	mm İÇ Ø	mm H	kg AĞIRLIK	m <sup>3</sup>	KUTU	FİYAT
40	26	70	2.75	0.0054	50	

Hammadde : Zamak

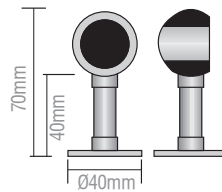

### KOD: 33206 OVAL BORU TUTUCU AÇIK

KROM

AÇIKLAMA	mm H	kg AĞIRLIK	m <sup>3</sup>	KUTU	FİYAT
15 x 30	75	1.60	0.0054	50	

Hammadde : Zamak

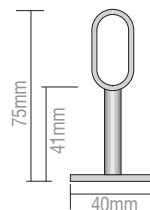

**KOD: 33207 OVAL BORU TUTUCU KAPALI**

KROM

AÇIKLAMA	mm H	kg AĞIRLIK	m <sup>3</sup>	KUTU	FİYAT
15 x 30	75	2	0.0054	50	

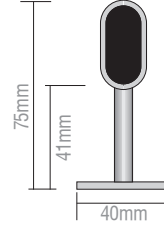

Hammadde : Zamak

**KOD: 33008 2 DELİKLİ ASKI FLANŞ**

ÇİNKO

KUTU	FİYAT
250	

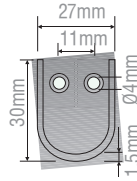

Hammadde : Metal

**KOD: 33077 4 DELİKLİ ASKI FLANŞ**

ÇİNKO

KUTU	FİYAT
100	

Hammadde : Metal



**KOD: 33024 OVAL FLANŞ ŞEFFAF**

ŞEFFAF

KUTU	FİYAT
300	

Hammadde : Şeffaf Kırılmaz Cam



**KOD: 33005 OVAL FLANŞ PİMLİ**

NIKEL

KUTU	FİYAT
200	

Hammadde : Zamak

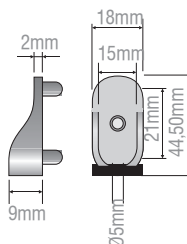

## Dolap Bağlantı Elemanları

### KOD: 33006 OVAL FLANŞ PİMSİZ

NIKEL

KUTU	FİYAT
200	

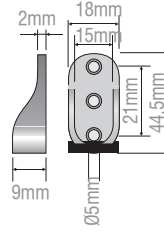

Hammadde : Zamak

### KOD: 33007 OVAL FLANŞ DÜZ (Eko)

NIKEL

KUTU	FİYAT
200	



Hammadde : Zamak

### KOD: 33013 OVAL FLANŞ PİMLİ (Eko)

NIKEL

KUTU	FİYAT
200	



Hammadde : Zamak

### KOD: 33012 OVAL FLANŞ MİNİ

NIKEL

KUTU	FİYAT
200	

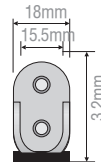

Hammadde : Zamak

### KOD: 33025 KÖŞELİ OVAL FLANŞ ŞEFFAF

ŞEFFAF

KUTU	FİYAT
100	



Hammadde : Şeffaf Kırılmaz Cam



**KOD: 33011 OVAL L FLANŞ**

NIKEL

AÇIKLAMA	mm G	mm H	KUTU	FİYAT
M4 Vidalı	19	63	150	

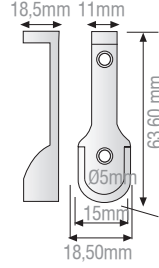

Hammadde : Zamak

**KOD: 33208 UZUN ASKI FLANŞ**

NIKEL

AÇIKLAMA	ÖLÇÜ	KUTU	FİYAT
M4 Diş	15 x 29	200	
M6 Diş	15 x 29	200	



Hammadde : Zamak

**KOD: 33026 KÖPRÜ FLANŞ ŞEFFAF**

ŞEFFAF

KUTU	FİYAT
50	



Hammadde : Şeffaf Kırılmaz Cam.

**ŞEFFAF ASKI BORUSU**

ŞEFFAF

KOD	AÇIKLAMA	ÖLÇÜ	KUTU	FİYAT
15829	OVAL	15X30X300	25	
15830	YUVARLAK	25X300	25	



Hammadde : Şeffaf Kırılmaz Cam.

# RAF BAĞLANTI ELEMENLARI



**KOD: 33308 ÇİVİLİ RAF PİMİ**

BEYAZ KAHVE KREM SİYAH ŞEFFAF

mm Ø	kg AĞIRLIK	KUTU	PLASTİK RENKLER	ŞEFFAF
9	1.86	2000		
11	2	2000		

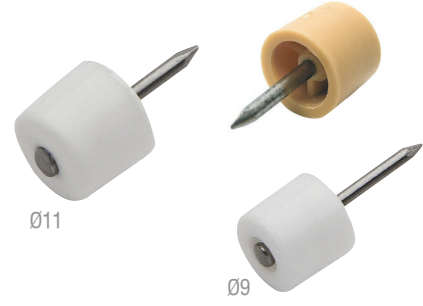
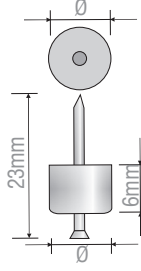

Hammadde : Metal & Plastik

Opsiyonel Renklerde Minimum Sipariş 20.000 Adettir. Termin süresi 15 gündür.

**KOD: 33307 PLASTİK BAŞLI METAL RAF PİMİ**

BEYAZ KAHVE KREM ŞEFFAF

mm Ø	kg AĞIRLIK	m <sup>3</sup> KUTU	PLASTİK RENKLER	ŞEFFAF
5	9.34	0.0079	3000	

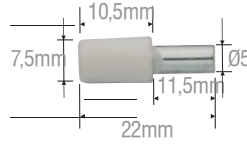

Hammadde : Metal & Plastik

Opsiyonel Renklerde Minimum Sipariş 15.000 Adettir. Termin süresi 15 gündür.

**KOD: 33328 YUVARLAK RAF PİMİ**

ŞEFFAF

mm Ø	kg AĞIRLIK	KUTU	FİYAT
5	1.01	1000	



Hammadde : Şeffaf Kırılmaz Cam

**KOD: 33310 KRİSTAL RAF PİMİ**

ŞEFFAF

mm Ø	kg AĞIRLIK	m <sup>3</sup> KUTU	FİYAT
5	3.49	0.0054	1000

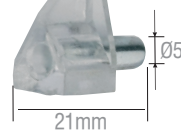

Hammadde : Metal & Plastik

**KOD: 33306 PLASTİK RAF PİMİ**

BEYAZ

mm Ø	kg AĞIRLIK	m <sup>3</sup> KUTU	FİYAT
5	6.84	0.0027	3000
6	6.84	0.0027	3000

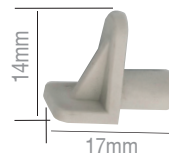

Hammadde : Plastik



## Raf Bağlantı Elemanları

### KOD: 33309 METAL RAF PİMİ OTOMAT

ÇİNKO

mm	kg	m <sup>3</sup>	KUTU	FİYAT
Ø 5	AĞIRLIK 7.38	0.0017	3000	

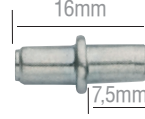

Hammadde : Otomat

### KOD: 3333 EKO VANTUZLU RAF PİMİ

NİKEL

mm	KUTU	FİYAT
Ø 5	1.000	

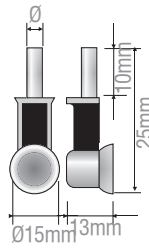

Hammadde : Otomat+Plastik

### KOD: 33303 VANTUZLU RAF PİMİ DAR

NİKEL

mm	kg	m <sup>3</sup>	KUTU	FİYAT
Ø 5	AĞIRLIK 1.60	0.0027	300	

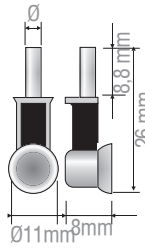

Hammadde : Zamak+Plastik

### KOD: 33304 VANTUZLU RAF PİMİ GENİŞ

NİKEL

mm	kg	m <sup>3</sup>	KUTU	FİYAT
Ø 5	AĞIRLIK 1.58	0.0027	300	

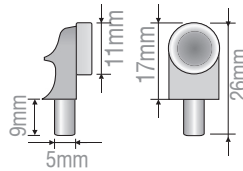

Hammadde : Zamak+Plastik

### KOD: 33335 VANTUZLU L RAF PİMİ

NİKEL

mm	KUTU	FİYAT
Ø 5	1.000	



Hammadde : Otomat

**KOD: 33305 L RAF PİMİ**

 NİKEL

mm	kg	m <sup>3</sup>	KUTU	FİYAT
Ø 5	AĞIRLIK 3.54	0.0027	1000	

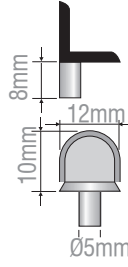

Hammadde : Zamak

**KOD: 33336 APEX RAF PİMİ DÜZ**

 NİKEL

mm	KUTU	FİYAT
Ø 5	1000	



Hammadde : Zamak

**KOD: 33337 APEX RAF PİMİ PİMLİ**

 NİKEL

mm	KUTU	FİYAT
Ø 5	1000	



Hammadde : Zamak

**KOD: 33338 L RAF TUTUCU**

 NİKEL

KUTU	FİYAT
250	



Hammadde : Zamak

**KOD: 33325 RAF PİMİ KOVANI**

BEYAZ

mm	KUTU	FİYAT
Ø 5	3000	

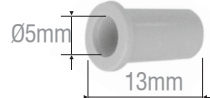

Hammadde : Plastik

## Raf Bağlantı Elemanları

### KOD: 33313 ÇİVİLİ CONTALI RAF PİMİ

NIKEL

mm	kg	m <sup>3</sup>	KUTU	FİYAT
Ø	AĞIRLIK			
8	3	0.0038	500	

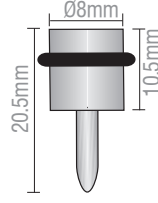

Hammadde : Otomat+Kauçuk

### KOD: 33312 DÜZ CONTALI RAF PİMİ

NIKEL

mm	kg	m <sup>3</sup>	KUTU	FİYAT
Ø	AĞIRLIK			
5	3,75	0.0038	500	

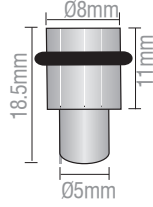

Hammadde : Otomat+Kauçuk

### KOD: 33311 ÇİFT CONTALI RAF PİMİ

NIKEL

mm	kg	m <sup>3</sup>	KUTU	FİYAT
Ø	AĞIRLIK			
5	2	0.0038	500	

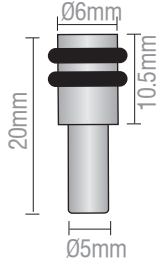

Hammadde : Otomat+Kauçuk

### KOD: 33314 VİDALI RAF PİMİ

NIKEL

mm	mm	kg	m <sup>3</sup>	KUTU	FİYAT
Ø	L	AĞIRLIK			
6.5	20	3,75	0.0038	500	

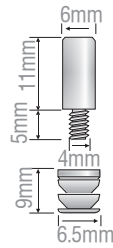

Hammadde : Otomat



**KOD: 33315** CONTALI VİDALI RAF PİMİ

NIKEL

mm Ø	mm L	kg AĞIRLIK	m <sup>3</sup>	KUTU	FİYAT
6.5	20	3,75	0.0038	500	

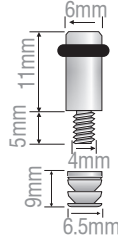

Hammadde : Otomat+Kauçuk

**KOD: 33318** CONTALI RAF PİMİ

KROM

mm L	mm Ø	kg AĞIRLIK	m <sup>3</sup>	KUTU	FİYAT
15	10	1	0.0038	100	
18	12	1,5	0.0038	100	

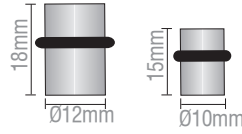

Hammadde : Otomat+Kauçuk

**KOD: 33319** TAPALI RAF PİMİ

KROM

mm L	mm Ø	kg AĞIRLIK	m <sup>3</sup>	KUTU	FİYAT
20	12	3	0.0038	200	

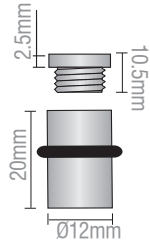

Hammadde : Otomat+Kauçuk

**KOD: 33606** TABELA VİDASI

KROM

mm Ø	mm L	kg AĞIRLIK	m <sup>3</sup>	KUTU	FİYAT
13	20	4.20	0.0058	200	
17	10	2.70	0.0058	250	
17	20	5.40	0.0058	100	
17	27	7.40	0.0058	100	
17	40	10.50	0.0058	70	

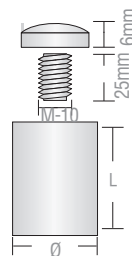

Hammadde : Otomat

## Raf Baęlantı Elemanları

### KOD: 33302 CAM RAF TAŐIYICI PİMSİZ

KROM NİKEL

AÇIKLAMA	kg	m <sup>3</sup>	KUTU	KROM	NİKEL
Metal Vidalı	2.51	0.0036	200		
Plastik Vidalı	1.73	0.0036	200		

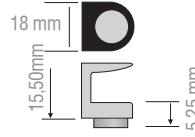

Hammadde : Zamak

### KOD: 33301 CAM RAF TAŐIYICI (PİMLİ)

KROM NİKEL

AÇIKLAMA	kg	m <sup>3</sup>	KUTU	KROM	NİKEL
Metal Vidalı	2.88	0.0036	200		
Plastik Vidalı	2.68	0.0036	200		

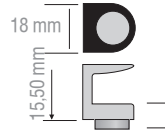

Hammadde : Zamak

### KOD: 33104 RAF ETEJERİ

KROM

AÇIKLAMA	mm	mm	kg	m <sup>3</sup>	KUTU	FİYAT
18 mm	30	35	3.25	0.0054	50	

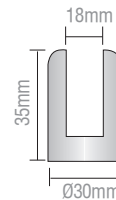

Hammadde : Zamak

### KOD: 33108 FLAMİNGO RAF ETEJERİ

KROM MAT KROM

AÇIKLAMA	mm	mm	mm	kg	m <sup>3</sup>	KUTU	KROM	M.KROM / SATEN
10 mm	130	28	62	2.60	0.0054	10		



Hammadde : Zamak+Pls.

Max. Sıkıřtırma 30 mm

**KOD: 33101 RADÜSLÜ CAM ETEJERİ**

KROM

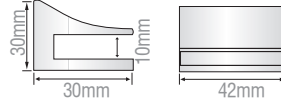

AÇIKLAMA	mm L	mm G	mm H	kg AĞIRLIK	m <sup>3</sup>	KUTU	FİYAT
10 mm	42	30	30	3.14	0.0054	50	

Hammadde : Zamak

**KOD: 33106 U CAM ETEJERİ 8-10**

KROM

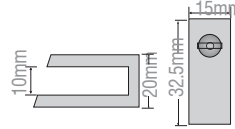

AÇIKLAMA	mm L	mm G	mm H	kg AĞIRLIK	m <sup>3</sup>	KUTU	KROM	M.KROM / SATEN
10 mm	32.5	15	20	5.82	0.0054	200		

Hammadde : Zamak

**OVAL CAM ETEJERİ**

KROM MAT KROM SATEN

KOD	mm L	mm G	mm H	kg AĞIRLIK	m <sup>3</sup>	KUTU	FİYAT
33102	43	25	22	2.10	0.0054	100	
33103	34	25	16	2.00	0.0054	200	

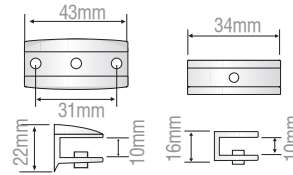

Hammadde : Zamak

**KOD: 33105 PELİKAN RAF ETEJERİ**

KROM MAT KROM SATEN

mm L	mm G	mm H	kg AĞIRLIK	m <sup>3</sup>	KUTU	FİYAT
40	25	42	3.53	0.0054	50	

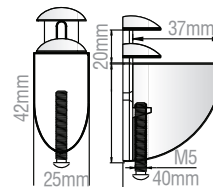

Hammadde : Zamak+Plastik



# GARDROP AKSESUARLARI



## Gardrop Aksesuarları

### KOD: 38015 DÜZ PANTOLONLUK

cm L	cm G	KUTU	FİYAT
37	38	12	
37	40	12	
37	45	12	
37	50	12	
37	55	12	
37	60	12	
47	38	11	
47	40	10	
47	45	10	
47	50	10	
47	55	10	
47	60	10	

Hammadde : Plastik & Alüminyum



### KOD: 38016 SEPETLİ PANTOLONLUK

cm L	cm G	KUTU	FİYAT
47	38	10	
47	40	10	
47	45	10	
47	50	10	
47	55	10	
47	60	10	

Hammadde : Plastik & Alüminyum



### KOD: 38001 ELBİSE ASKI ASANSÖRÜ

GRİ SİYAH - BEYAZ

KUTU	FİYAT
12	

Hammadde : Plastik & Alüminyum



MOBİLYA AKSESUARLARI

### KOD: 38009 Katlanır Ütü Masası

siyah

cm L	kg AĞIRLIK	m <sup>3</sup> KUTU	FİYAT
400	8,050	330 x 495 x 150	1

Hammadde : Metal



**KOD: 38022** ÇAMAŞIRLIK



AÇIKLAMA	KUTU	KOLI	FİYAT
Çamaşırılık	1	40	

**KOD: 38023** EŞARPLIK



AÇIKLAMA	KUTU	KOLI	FİYAT
Eşarpık	1	40	

**KOD: 38021** KEMERLİK - SAATLİK



AÇIKLAMA	KUTU	KOLI	FİYAT
Kemerlik - Saatlik	1	40	

**KOD: 38024** PANTOLONLUK - HAVLULUK



AÇIKLAMA	KUTU	KOLI	FİYAT
Pantolonluk - Havluluk	1	40	



**KOD: 36701 KAŞIKLIK**

GRI  BEYAZ

cm L	mm G	KUTU	DESENİ GRI	PARLAK BEYAZ
30	49	15		
37	49	15		
42	49	15		
47	49	15		
55	49	15		
62	49	15		
67	49	15		
75	49	15		
85	49	15		
97	49	15		
Kepçelik		15		



Kepçelik 55 x 49 Cm



Hammadde : Plastik

**KOD: 36709 KÜÇÜK ÇEKMECE KAŞIKLIK**

BEYAZ  AÇIK KAHVE

ÖLÇÜ	KUTU	FİYAT
377 X 271 X 48	24	

Hammadde : Plastik



**KOD: 36710 BÜYÜK ÇEKMECE KAŞIKLIK**

BEYAZ  AÇIK KAHVE

ÖLÇÜ	KUTU	FİYAT
386 X 312 X 70	24	

Hammadde : Plastik



**KOD: 36711 DOUBLE ÇEKMECE KAŞIKLIK**

BEYAZ  SİYAH GRI

ÖLÇÜ	KUTU	FİYAT
386 X 312 X 70	24	

Hammadde : Plastik



# SÜRGÜ MEKANİZMALARI



## 70200 Eko 80 KG Sürgü Kapak Mekanizması

\* Ayarlı Alt-Üst Makara

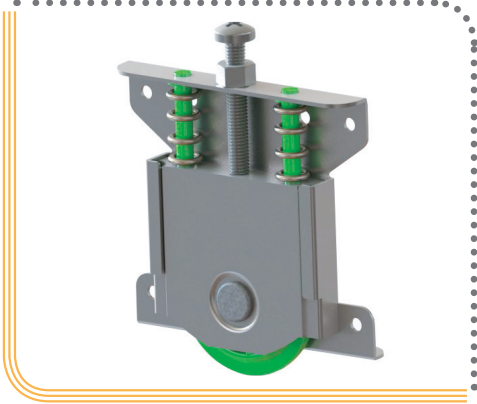

KOD	AÇIKLAMA	KUTU	KOLİ	FİYAT
70200	Eko 80 Kg Sürgü Kapak Mekanizması	4 Adet	120 Adet	

## 70202 Eko Lux 80 KG Sürgü Kapak Mekanizması

\* Ayarlı Alt-Üst Makara

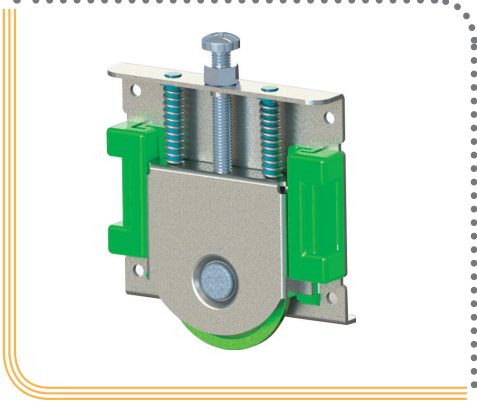

KOD	AÇIKLAMA	KUTU	KOLİ	FİYAT
70202	Eko Lük 80 Kg Sürgü Kapak Mekanizması	4 Adet	120 Adet	

## 70220 Standart 80 KG Sürgü Kapak Mekanizması

\* Ayarlı Alt-Üst Makara

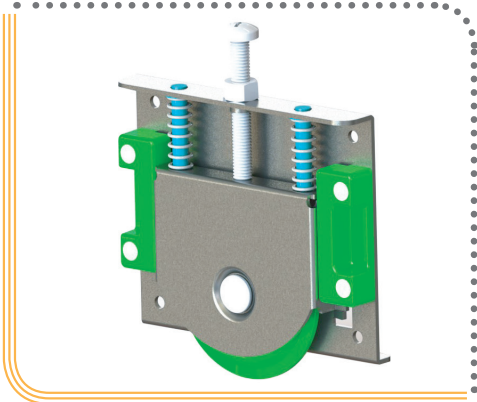

KOD	AÇIKLAMA	KUTU	KOLİ	FİYAT
70220	Standart 80 Kg Sürgü Kapak Mekanizması	4 Adet	120 Adet	



## 70022 Standart 100 KG Sürgü Kapak Mekanizması

\* Ayarlı Alt-Üst Makara

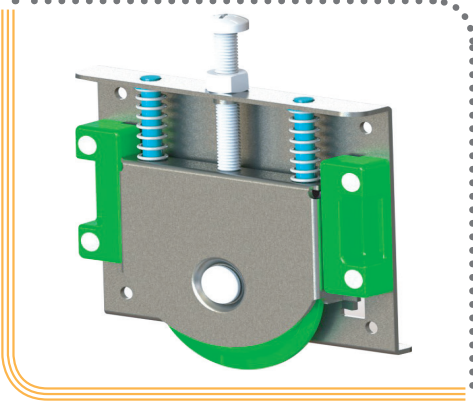

KOD	AÇIKLAMA	KUTU	KOLİ	FİYAT
70022	Standart 100 Kg Sürgü Kapak Mekanizması	4 Adet	120 Adet	

## 70390 80 KG Sürgü Kapak Mekanizması

\* Ayarlı Alt-Üst Makara

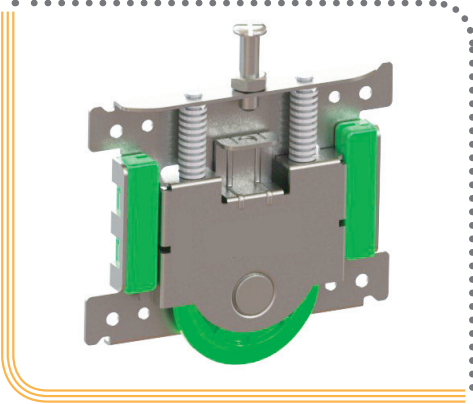

KOD	AÇIKLAMA	KUTU	KOLİ	FİYAT
70390	80 Kg Sürgü Kapak Mekanizması	4 Adet	120 Adet	

• Tutma Mandalı Sayesinde Montaj Kolaylığı Raydan Çıkmama Özelliđi

## 70395 100 KG Sürgü Kapak Mekanizması

\* Ayarlı Alt-Üst Makara

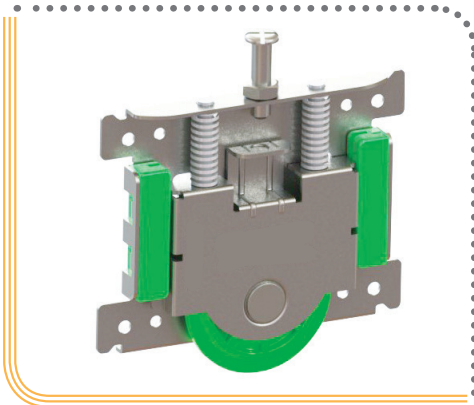

KOD	AÇIKLAMA	KUTU	KOLİ	FİYAT
70395	100 Kg Sürgü Kapak Mekanizması	4 Adet	120 Adet	

• Tutma Mandalı Sayesinde Montaj Kolaylığı Raydan Çıkmama Özelliđi

## 70396 PKM-80B Eko Mekanizma

\* Ayarlı Alt-Üst Makara

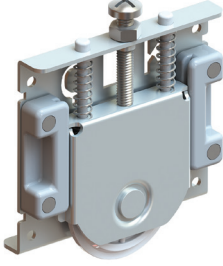

KOD	AÇIKLAMA	KUTU	KOLİ	FİYAT
70396	80 Kg Sürgü Kapak Mekanizması	4 Adet	120 Adet	

• Opsiyonel Üründür. Termin Süresi 15 gündür.

## 70397 PKM-80B Eko Mekanizma (Yeni)

\* Ayarlı Alt-Üst Makara

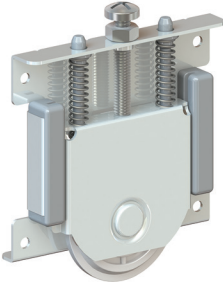

KOD	AÇIKLAMA	KUTU	KOLİ	FİYAT
70397	80 Kg Sürgü Kapak Mekanizması	4 Adet	120 Adet	

## 70398 PKM-80B Lüks Vega Mekanizma

\* Ayarlı Alt-Üst Makara

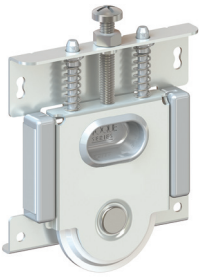

KOD	AÇIKLAMA	KUTU	KOLİ	FİYAT
70398	80 Kg Sürgü Kapak Mekanizması	4 Adet	120 Adet	

• Opsiyonel Üründür. Termin Süresi 15 gündür.

## 70399 PKM-80D Mekanizma

\* Ayarlı Alt-Üst Makara

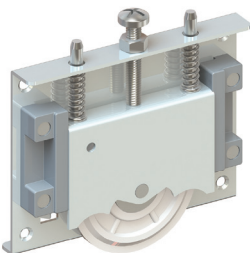

KOD	AÇIKLAMA	KUTU	KOLİ	FİYAT
70399	80 Kg Sürgü Kapak Mekanizması	4 Adet	120 Adet	

• Opsiyonel Üründür. Termin Süresi 15 gündür.

# TEZGAH BİRLEŐTİRME VE MENFEZLER

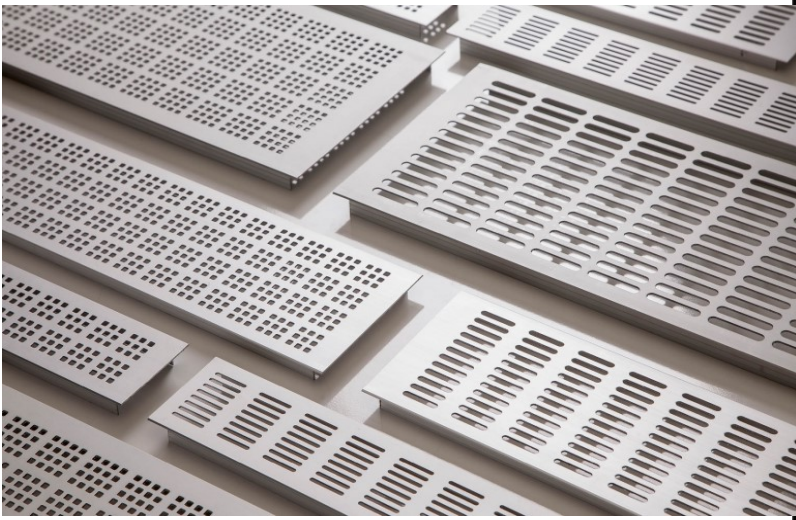



## MUTFAK TEZGAH PROFİLLERİ

\* 60435 YAN KAPAMA

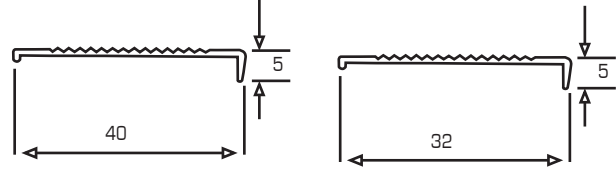

KOD	MT / BOY	YÜZEY	PK./TK.	FIY/TK.	PK./FIY
604353060	30X60	Naturel	25		
604354060	40X60	Naturel	25		

\* 60440 TEZGAH ARA ÇİTA

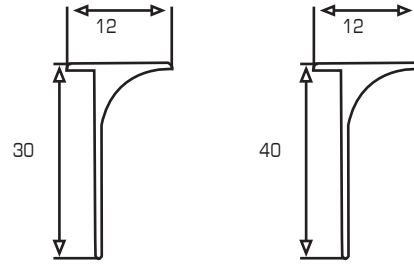

KOD	MT / BOY	YÜZEY	PK./TK.	FIY/TK.	PK./FIY
604403060	30X60	Naturel	25		
604404060	40X60	Naturel	25		

\* 60444 TEZGAHT ÇİTA

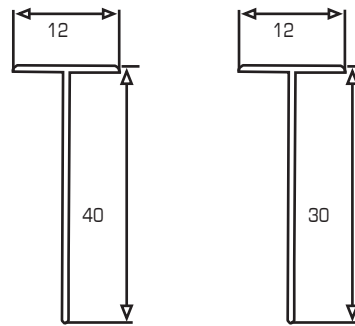

KOD	MT / BOY	YÜZEY	PK./TK.	FIY/TK.	PK./FIY
604443060	30X60	Naturel	25		
604444060	40X60	Naturel	25		

## HAVALANDIRMA MENFEZLERİ

61671

7 CM HAVALANDIRMA MENFEZİ

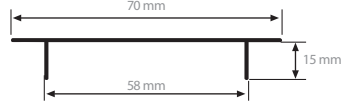
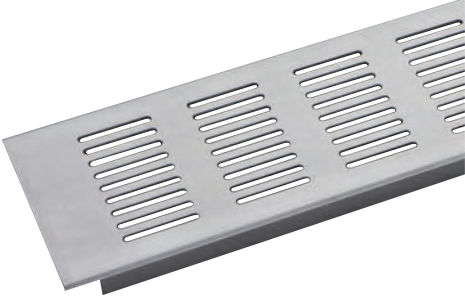

ÜRÜN ADI	KOLI / PAKET ADEDİ	UZUNLUK	BİRİM	RENK	FIYAT/Ad.
7 CM HAVALANDIRMA MENFEZİ	10	7X20	CM	MAT ELOKSAL	
		7X25			
		7X30			
		7X35			
		7X40			
		7X45			
		7X50			
		7X55			
		7X60			
		7X65			
		7X70			
		7X75			
		7X80			
		7X85			
7X90					
7X95					
7X100					

61672

12 CM HAVALANDIRMA MENFEZİ

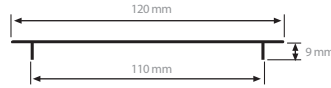
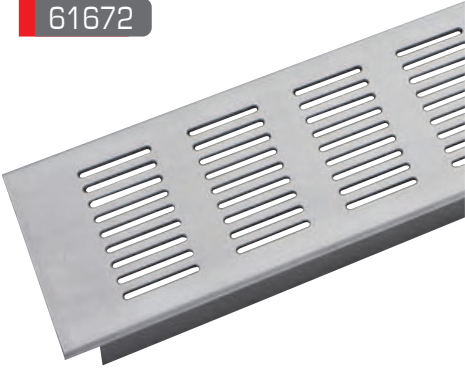

ÜRÜN ADI	KOLI / PAKET ADEDİ	UZUNLUK	BİRİM	RENK	FIYAT/Ad.
12 CM HAVALANDIRMA MENFEZİ	10	12X20	CM	MAT ELOKSAL	
		12X25			
		12X30			
		12X35			
		12X40			
		12X45			
		12X50			
		12X55			
		12X60			
		12X65			
		12X70			
		12X75			
		12X80			
		12X85			
		12X90			
		12X95			
12X100					

**Not:** 100 cm sonrası özel ölçüler için fiyat bilgisi alınız.

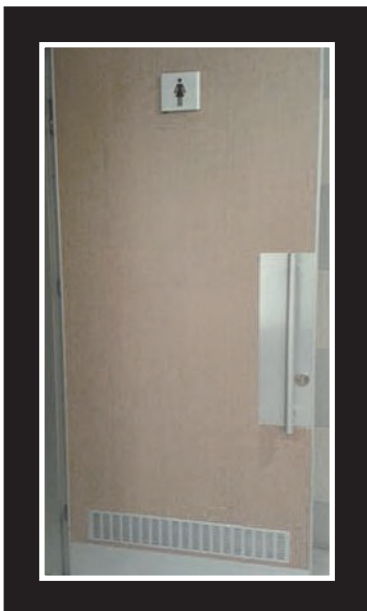













## **GENEL NOTLAR :**

1. Siparişlerinizi fax veya e-posta ile bildiriniz.
2. Üretim hatası olmayan ürünler iade alınmaz.
3. Mal teslim yeri **İSTANBUL** olup, nakliye alıcıya aittir.
4. Özel ürün siparişleri sözleşmeye tabidir ve iade alınmaz.
5. Bedeli ödenmemiş siparişlerinizde yeni fiyat listesi geçerlidir.
6. Sipariş miktarlarını, kutu miktarına göre veriniz.
7. Yeni fiyat listesi, bir önceki fiyat listesini geçersiz kılar.
8. Kargo ve Ambardaki ürünlerin sorumluluğu müşteriye aittir.
9. Her ay sonu bakiyeye bakılmaksızın cari hesap kapatılır.
10. Fiyatlarımıza **KDV** dahil değildir.
11. Teslimatlar, satış koşulları ve ödeme performansına göre gerçekleştirilir.
12. Listemizde yer alan modellerin bir kısmı, Endüstriyel tasarım tescil belgesi ile koruma altına alınmıştır.
13. Listemizde bulunmayan **MODEL-RENK** ve **ÖLÇÜLER** için bilgi alınız.
14. Fotoğraf, gerçek ürün renkleriyle farklılık gösterebilir.
15. GÜZEL METAL, tipografik hatalardan sorumlu değildir.
16. GÜZEL METAL, fiyat değişikliği hakkını saklı tutar.



**blum**<sup>®</sup>



**ALBATUR**<sup>®</sup>  
produces quality

**mitreapel**



**MEPA**<sup>®</sup>

**MESAN**<sup>®</sup>  
SHOP DESIGN



**SYSTEM**



**Titus+**



**metali**<sup>®</sup>  
furniture accessories



**İLKE**   
İTHALAT ve İHRACAT  
DİŞ TİC. LTD. ŞTİ.





# ILKE

İTHALAT ve İHRACAT  
DIŞ TİC. LTD. ŞTİ.



2023

mobilya

aksesuarları

HIRDAVAT & NALBURIYE



[info@ilkeihracat.com](mailto:info@ilkeihracat.com)



ikiteli O.S.B Mah . ikitelli  
Keresteciler Sitesi 11B Blok  
BASAKSEHIR - ISTANBUL



T : +90 212 670 20 05  
F : +90 212 670 20 04  
G : +90 533 091 88 98

